

USER MANUAL

Phoenix Charger

12/30

12/50

24/16

24/25



Copyrights © 1999, 2000, 2001 Victron Energy B.V.
All Rights Reserved

This publication or parts thereof, may not be reproduced in any form, by any method, for any purpose.

VICTRON ENERGY B.V. MAKES NO WARRANTY, EITHER EXPRESSED OR IMPLIED, INCLUDING BUT NOT LIMITED TO ANY IMPLIED WARRANTIES OF MERCHANTABILITY OR FITNESS FOR A PARTICULAR PURPOSE, REGARDING THESE VICTRON ENERGY PRODUCTS AND MAKES SUCH VICTRON ENERGY PRODUCTS AVAILABLE SOLELY ON AN “AS – IS” BASIS.

IN NO EVENT SHALL VICTRON ENERGY B.V. BE LIABLE TO ANYONE FOR SPECIAL, COLLATERAL, INCIDENTAL, OR CONSEQUENTIAL DAMAGES IN CONNECTION WITH OR ARISING OUT OF PURCHASE OR USE OF THESE VICTRON ENERGY PRODUCTS. THE SOLE AND EXCLUSIVE LIABILITY TO VICTRON ENERGY B.V., REGARDLESS OF THE FORM OF ACTION, SHALL NOT EXCEED THE PURCHASE PRICE OF THE VICTRON ENERGY PRODUCTS DESCRIBED HEREIN.

For conditions of use and permission to use this manual for publication in other than the English language, contact Victron Energy B.V.

Victron Energy B.V. reserves the right to revise and improve its products as it sees fit. This publication describes the state of this product at the time of its publication and may not reflect the product at all times in the future.

SAFETY AND REGULATORY INFORMATION

General

- Review related documentation of this product to familiarise yourself with safety markings and instructions before you operate the equipment.
- This product has been designed and tested in accordance with international standards. Only use the equipment for the intended purpose of application.
- **WARNING: RISK OF ELECTRIC SHOCK.** The product is used in conjunction with a permanent energy source (battery). Even if the equipment is switched off, dangerous electrical voltages may appear at the in- and/or output terminals. Always disconnect AC power and battery before maintaining or servicing the product. A Ground Fault Circuit Interruptor (GFCI) must be installed in the AC supply circuit.
- There are no user-serviceable parts inside. Do not remove the frontplate or operate the product without the frontplate fitted. Refer all servicing to qualified personnel.
- Never use the product in locations where there is danger of gas- or dust explosions. Consult your supplier to ensure that the product is intended for use in conjunction with the battery. Always apply the battery manufacturer's safety instructions.
- Caution: never carry heavy loads without assistance.
- Explosive gases can be generated during charging of a lead-acid battery. Prevent open flame and sparks. Take care of sufficient ventilation during charging.
- Never try to recharge non-rechargeable batteries.
- The on/off switch at the front panel of this battery charger does not isolate the main circuits.
- A double-pole switch with a minimum contact distance of 3mm must be incorporated in the fixed mains input wiring of the installation

Installation

- The installation of this product must be performed by qualified personnel.
- Always refer to the installation section in the operator's manual before applying power to the equipment.
- This is a Safety Class I product (provided with a protective earthing terminal). An uninterruptible safety earth ground must be provided at the AC in/output terminals. An additional grounding point is located at the outside of the product. Whenever it is likely that the grounding protection has been impaired, the product must be made inoperative and secured against any unintended operation; refer to qualified service personnel.

- Make sure that fuses and circuit breakers are provided in the connecting wires. Never replace a safety component by a different type. Consult the manual for determining the correct component.
- Make sure that all cables and wiring in the installation are anchored such that the conductors are relieved from strain and twisting.
- Before applying power, verify that the available power source matches the configuration settings of the product as described in the manual.
- Ensure that the environmental conditions are suitable for operation of the equipment. Never operate the product in a wet or in a dusty environment.
- Always allow enough free space around the product for ventilation and make sure that ventilation vents are not blocked.
- Be sure that the demanded power does not exceed the capacity of the product.
- This device is a continuous duty automatic charger for rechargeable open, sealed and gel lead acid batteries (max. 12 x 2V cells)
- For supply connection use wires suitable for at least 75°C (167°F).
- **CAUTION:** Replace defective cords or wires immediately.

Transport and storage

- When storing or transporting the product make certain that mains power and battery leads are disconnected.
- No liability can be accepted for any transport damage when equipment is shipped in non-original packaging.
- Store the product in a dry location, storage temperature must be between -20°C and 60°C.
- Refer to the battery manufacturer manual concerning transport, storage, charging, recharging and disposal of the battery.

DESCRIPTION

Technology

The Phoenix Charger is a fully high-frequency switched battery charger. The input is electronically powerfactor corrected by the first powerstage.

The next stage gives provision for galvanic isolation and a perfect DC voltage at the output terminals.

A very accurate charging state of the battery is guaranteed because the charging process is microcontroller regulated.

The internal electronic parts are protected against moisture and dirt by means of a special coating, which assures a long lifetime of your battery charger.

Two high-capacity batteries and an additional low-capacity battery can be charged with this charger.

Adaptive Charging

The new Phoenix Charger uses the Adaptive Charging Characteristic. The Adaptive Charging Characteristic distinguishes from other charging characteristic on several topics. The main 3 topics are Rapid Charging, Battery Safe Mode and All Season Mode.

Generally speaking the Phoenix Charger will adapt to the connected batteries.

Rapid charging

In the first stage, the bulk phase, of the charging cycle the batteries are charged with higher current than traditional charging methods. The bulk phase will stop at the point where the battery voltage will be 14,4V or 28,8V. From here the absorption phase will start.

Based on the measured bulk time the length of the absorption time will be calculated. For this the charger micro-controller will monitor several parameters of the battery.

BatterySafe mode

But what if your battery needs a higher absorption voltage? The charger will gradually raise the applied voltage to the battery until it reaches the set absorption voltage. This phase we call the BatterySafe Mode. It will save your battery from destruction by overcharging.

The Phoenix Charger is temperature compensated. The charger will recalculate different values based on the battery temperature.

All Season mode

For periods where you do not use your batteries and the mains is applied to the charger, the Phoenix Charger will reduce its float voltage. By doing this we reduce the gassing in your battery so they will not run dry after a longer period of not using your battery.

To keep your batteries in shape the Phoenix Charger will raise the applied voltage once a week. This we call the repetitive absorption.

Operation

The battery charger charges the battery with a 3-stage adaptive charging characteristic, see specifications at the back for details. It can remain connected to the battery continuously, without increased gas formation, caused by overcharging, taking place.

The charger can be used for different types of batteries but the default settings are for Sonnenschein A200 dryfit gel batteries. See specifications for other pre-programmed battery types.

For use with other types of batteries please contact your battery supplier to inform you about the right charging voltages. If necessary let the Phoenix Charger be readjusted.

The full charging current of the Phoenix Charger is divided in two main outputs.

An extra output with limited charge capacity is available to charge a starter battery for example.

The charger is protected against short-circuit at the outputs and too high ambient temperature.

Temperature sensor

The Phoenix Charger is factory shipped with a temperature sensor. Its function is to measure the battery temperature and adjust the charging voltages accordingly. By this means superior charging is achieved and a longer lifetime of the battery is assured.

Voltage sense

Using the Voltage sense connection will compensate the battery cable loss.

Controls

The Phoenix Charger will start charging by switching it **ON** with the switch at the front panel. One of the LED's at the front will indicate the progress of charge state:

Battery is less than 80% charged.

Battery is approximately charged for 80%. If Bulk LED is illuminating as well the set absorption voltage has not yet been reached (Battery Safe Mode).

Battery is fully charged and will be kept charged with trickle charge.

An output fuse is defective or the ambient temperature of the charger is too high.

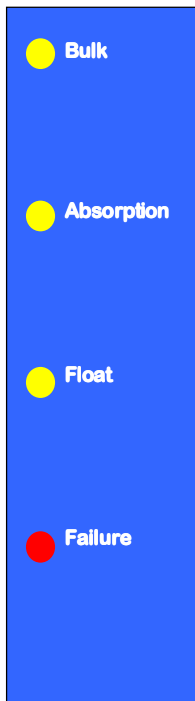

The Phoenix Charger will stop charging by switching it **OFF** with the switch at the front panel.

Equalize a traction set

This is done at a higher voltage than most DC-equipment can handle so all consumer electronics should be disconnected before equalizing the battery.

- Put the charger in off position. Switch **ON-OFF-ON** within 2 seconds.
- You'll see all the LED's flashing 5 times. After the 5th time all LEDs illuminate in sequence:
- Bulk –switch **OFF-ON** when this LED lights up. Now the charger increases its voltage up to 1 Volt above Absorption voltage for a 12V model or 2 Volts for a 24V model. The maximum current in this mode is limited to ¼ of the adjusted maximum charge current. The charger will stay in this mode for 1 hour and then switches to Float mode. Equalizing will only work with an already charged battery. If the battery voltage remains too low (see specs) for > 60 seconds the charger switches to Bulk mode and continues charging according normal charging characteristic.

Force to Absorption mode for fixed time

In certain circumstances it can be desirable to charge the battery occasionally with Absorption voltage for a fixed time.

- Put the charger in off position. Switch **ON-OFF-ON** within 2 seconds.
- You'll see all the LED's flashing 5 times. After the 5th time a sequence starts:
- Bulk –wait.
- Absorption –switch **OFF-ON** when this LED lights up.

Now the charger will stay in Absorption mode for the default or adjusted fixed Absorption time.

Remote control

The Phoenix Charger can be remote controlled optionally. With the Phoenix Charger Control all indicators can be seen and additionally the charging current. With this remote control it is possible to temporarily limit the charging current. This could be useful in case of a low current mains connection in combination with other utility equipment.

TROUBLESHOOTING

Problem	Possible cause	Solution
Failure LED illuminates	The output fuses are defect	Return the product to your dealer
	The ambient temperature of the charger is too high	Put the charger in a cool and well ventilated environment
Charger does not function	The mains voltage is not ok	Measure the mains voltage and make it within specs
	The input fuse is defect	Return the product to your dealer
The battery doesn't get fully charged	A bad battery connection	Check the battery connections
	The Absorption voltage is wrongly adjusted	Consult your battery supplier and electrician and have the charging voltage adjusted
	The float voltage is wrongly adjusted	
	The battery capacity is too large	Make sure the charger matches the battery capacity
	The output fuses are defect	Return the product to your dealer
The battery is being overcharged	The Absorption voltage is wrongly adjusted	Consult your battery supplier and electrician and have the charging voltage adjusted
	The float voltage is wrongly adjusted	
	A single battery cell is defect	Replace the battery or the defect cell
	Too small a battery	Consult your battery supplier and electrician and have the charging current adjusted
	The ambient temperature of the battery is too high	Consult your electrician and let him connect a temperature sensor

INSTALLATION

WARNING: Qualified personnel only

Location

The Phoenix Charger must be installed in a dry, well-ventilated area.

Too high an ambient temperature has the consequence of lower output, shorter life or a complete shutdown of the Phoenix Charger. The Phoenix Charger is suitable for floor and wall mounting. However, for optimum cooling, a vertical position is recommended. The cables between the Phoenix Charger and the battery must be kept as short as possible to minimise cable losses.

Required tools and cables

- Socketdriver & socket 10 mm.
- Screwdriver no. 2.
- Crosshead screwdriver no. 2 phillips.
- Battery cables and external fuse:

Model	Length 0 - 6 m	Fuse
12/30	16 mm ²	40 AT
12/50	25 mm ²	60 AT
24/16	10 mm ²	20 AT
24/25	16 mm ²	30 AT

Cables longer than 6 m are not recommended. Cable eyes with M6 holes should be used. For supply connection use wires suitable for at least 75°C (167°F).

CAUTION: Replace defective cords or wires immediately.

Connection sequence

- Disconnect mains.
- Disconnect battery cables from the battery.
- Remove the frontplate.
- Remove carfuses if placed.
- Connect the housing of the charger to ground. The housing is fitted with an M4 ground screw for this purpose.
- Connect the accompanying temperature sensor to the +T-sense and –T-sense and mount the M8 cable-eye to one of the battery clamps. The connector is located on the front PCB.
- Voltage sense is recommended. Connect 0.75 mm² wires to +V-sense and –V-sense and use a 5 AT fuse near the battery for protection. The connector is located on the front PCB.
- Connect the starter battery (if present) to the Trickle-charge connector located near the minus-output bolt. Use a 25 AT carfuse near the battery for protection.

- If used, the Phoenix Charger Control panel can be connected by means of a standard 8-pole communication cable with 8-pole communication connector. The maximum length is 100 m.
- Connect battery cables to the charger. Note that there's only one "minus"- output to connect both battery minus poles. Use a fuse according the table near the battery for protection.
- Connect battery cables to the battery.
- Watch if the POLARITY LED does **NOT** illuminate.
- If it does reverse battery cables
- Put the car fuses in their sockets
- Connect the AC-in by means of a 3-core cable of 2.5 – 4 mm² flexible core to the AC-in terminal block. Note that a real PE-connection is strictly necessary.
- Replace the frontplate.

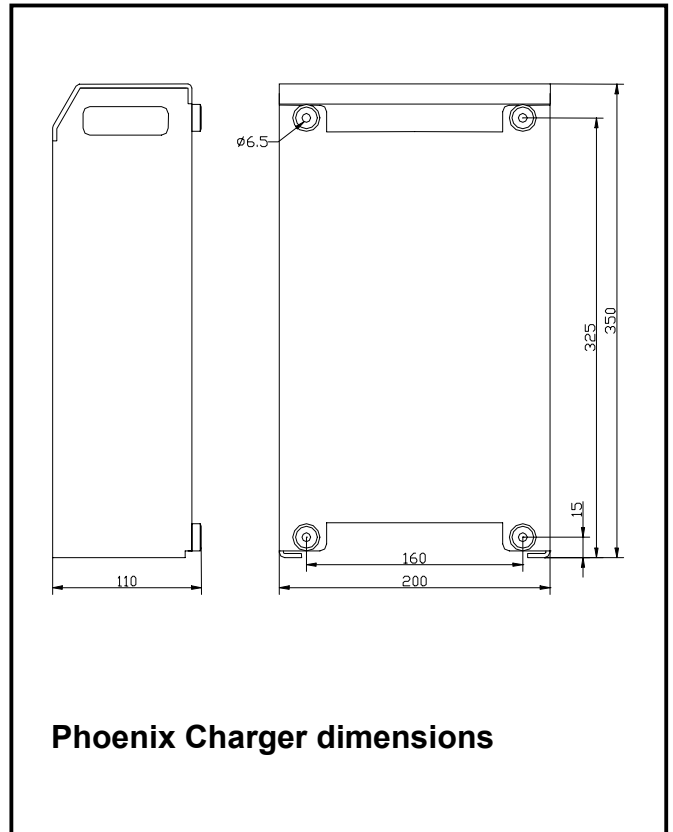

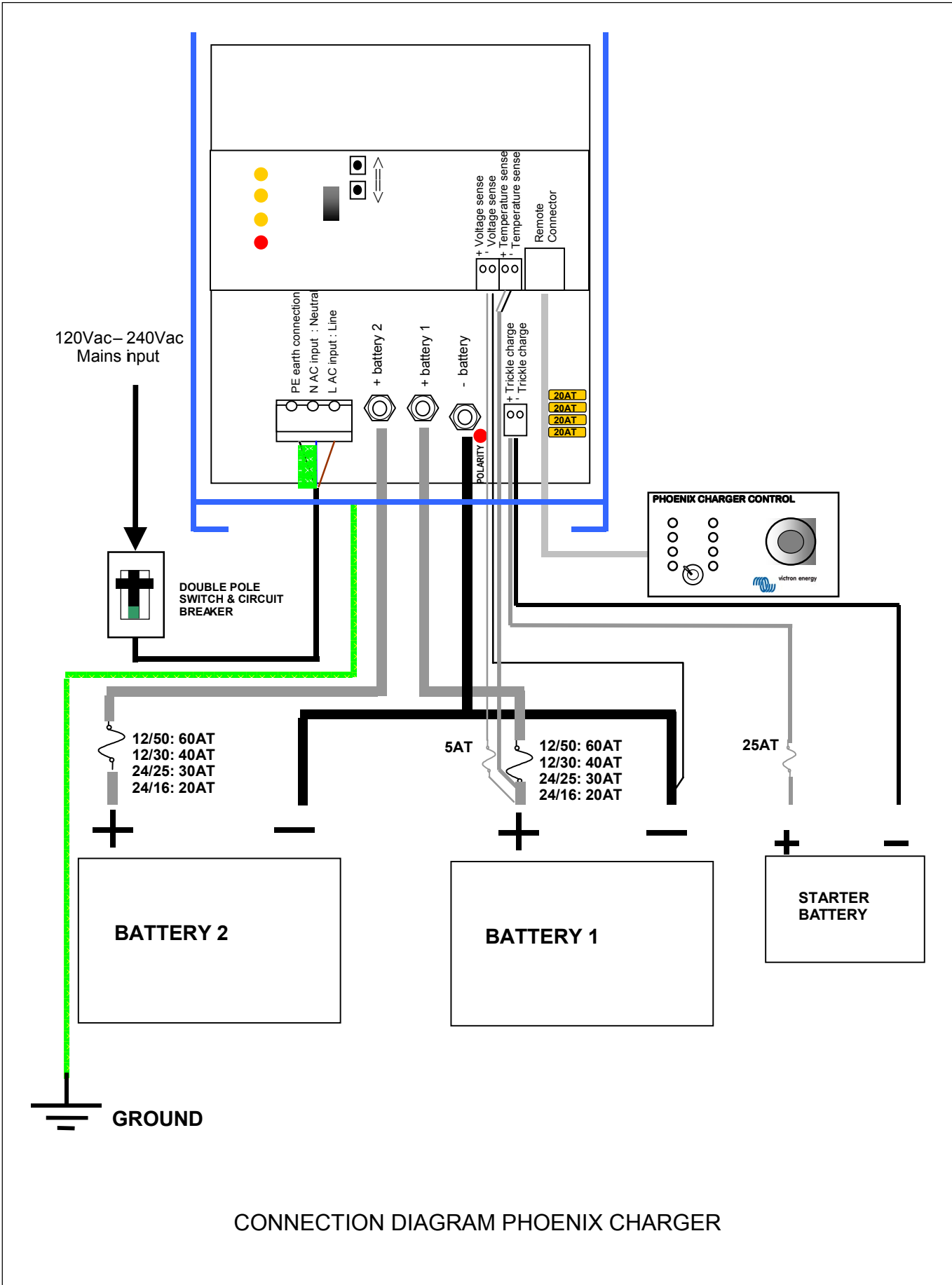

Adjustments without remote panel

WARNING: Always check with your battery supplier if the chosen charge characteristic is suitable for your battery and application

- Remove the frontplate and disconnect battery and Voltage sense and Temperature sense and connect a digital voltmeter to – and +1 output.

Bulk-current

- While switching on keep both the pushbuttons \uparrow & \downarrow pushed.
- Release pushbuttons.
- Bulk LED is flashing alternately with Failure LED.
- Push \uparrow for up and \downarrow for down.
- Reading as follows:
Discard first digit of DVM then multiply by 10, i.e:
22.50V =>2.50 => 25 Amps
15.00V =>5.00 => 50 Amps
- Switch the charger Off to store.

Absorption and Float voltage

- While switching on keep the pushbutton \uparrow pushed for Absorption voltage and \downarrow for Float-voltage.
- Release pushbuttons.
- Absorption or Float LED is flashing alternately with Failure LED.
- Push \uparrow for up and \downarrow for down.
- Reading on voltmeter as is.
- Switch the charger Off to store.
- Please note that in adjust-mode the Temperature sense compensation is not taken into account.

Warning: If the charger is not switched Off after an adjustment the new value will not be stored but will remain on the outputs. After 4 hours the charger continues the normal sequence with the old values. This can be useful if a forced high voltage is wanted to get some life in an assumed 'dead' battery.

Return to factory settings

- Switch the charger on.
- Keep the pushbutton \uparrow and/ or \downarrow pushed while switching **off**.
- The factory settings are restored.

When ready

- Connect battery and if applicable Voltage sense and Temperature sense.
- Replace the frontplate.

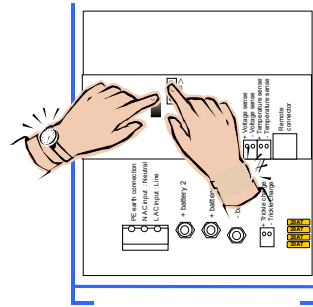

Adjusting maximum Bulk current

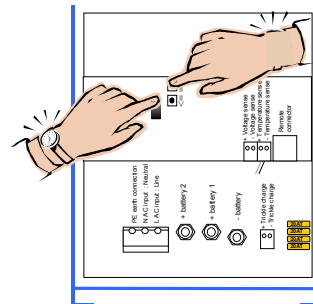

Adjusting Absorption voltage

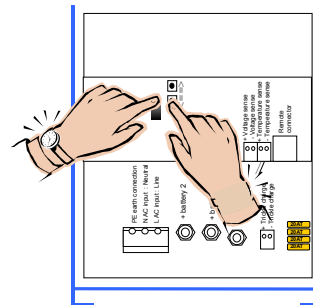

Adjusting Float voltage

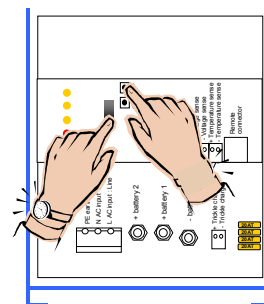



Restoring defaults

Adjustments with remote panel Phoenix Charger Control

WARNING: Always check with your battery supplier if the chosen charge characteristic is suitable for your battery and application

- Remove the frontplate and connect the Phoenix Charger Control panel to the 8-pin modular jack.
- Disconnect battery, Voltage sense and Temperature sense. A voltmeter is not required but may be useful.
- While switching on keep one of the pushbuttons \uparrow & \downarrow pushed.
- Release pushbutton.
- The adjust knob on the remote panel controls the adjust-mode; the LED's on the charger correspond with the knob as follows:

knob	adjust mode	charger LED's
0%	not impl.	Failure
10%	Bulk	Failure \leftrightarrow Bulk
20%	Absorption	Failure \leftrightarrow Absorption
30%	Float	Failure \leftrightarrow Float
40%	Rep. Abs. interval	Failure \leftrightarrow Abs./Float
50%	Rep. Abs. time	Failure \leftrightarrow Bulk/Abs.
60%	Max. Abs. time	Failure \leftrightarrow Bulk/Float
70%	Characteristic	Failure \leftrightarrow Bulk/Abs./Float
80%	Battery type	Failure/Abs. \leftrightarrow Float
90%	not impl.	Failure
100%	not impl.	Failure

- Push \uparrow for up and \downarrow for down.
- LED indicators on **remote panel** read the value as follows:
 LED flashing = 1 step 
 LED on = 2 steps 
 1 bar flashing = 9 steps
 Left bar is [step x10], right bar is [step x1].
 To read the Float and Absorption adjustment the lowest value in the table has to be added:

	12 V models	24V models
Bulk	0 – 50 A/30A; step 1A	0 – 25 A / 16 A; step 1 A
Abs	12.00 – 16.00 V; step 0.1 V	24.00 – 32.00 V; step 0.1 V
Float	12.00 – 16.00 V; step 0.1 V	24.00 – 32.00 V; step 0.1 V
Rep. Abs. int.	0 – 45 days; step 1 day ; def.= 7 days	
Rep. Abs. time	0 – 72 qu. of an hour; step 1 qu.; def = 4 qu.	
Max. Abs. time or Fixed Abs. time	1 – 8 hrs ; default = 4 hrs.	
Characteristic	1 = Fixed: Fixed Abs. time. default = 4 hrs. Rep. Abs. int. default = 1 day Rep. Abs. time. default = 2 qu. 2 = Adaptive 3 = Adaptive with BatterySafe mode (default)	

Battery type default = 1	Abs. Voltage		Float Voltage / Reduced Float		Max.Abs. time
0: User defined					
1: Sonnenschein Dryfit A200 gel	14.4 V	28.8 V	13.8 V / 13.0 V	27.6 V / 26.0 V	4 hrs.
2: Traction (tubular plate)	15.0 V	30.0 V	13.8 V / 13.0 V	27.6 V / 26.0 V	6 hrs.
3: Semitraction ¹	14.4 V	28.8 V	14.0 V / 13.0 V	28.0 V / 26.0 V	5 hrs.
4: Victory ¹	14.8 V	29.6 V	14.0 V / 13.0 V	28.0 V / 26.0 V	5 hrs.
	12V model	24V model	12V model	24V model	

- Turn the knob to another adjust-mode to store or switch Off to escape.
- Switch Off and On to start normal charging sequence.
- Replace the frontplate.

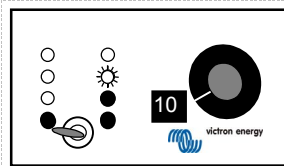

Max. Bulk current = 25 amps

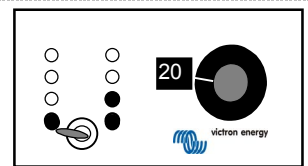

Absorption voltage =
 $12+(1 \times 2)+(2 \times 0.2) = 14.4$ volts (12V model)
 $24+(1 \times 2)+(2 \times 0.2) = 26.4$ volts (24V model)

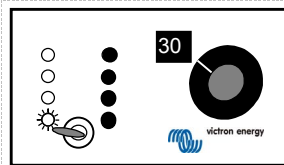

Float voltage =
 $12+(1 \times 1)+(4 \times 0.2) = 13.8$ volts (12V model)
 $24+(1 \times 1)+(4 \times 0.2) = 25.8$ volts (24V model)

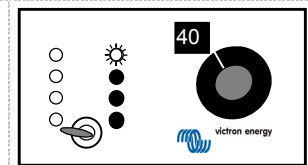

Repeated Absorption interval = 7 days

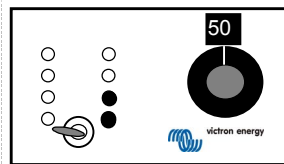

Repeated Absorption time = 4 quarters of an hour

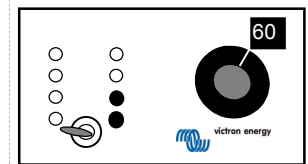

Maximum Absorption time = 4 hrs.



Characteristic = 1. Fixed mode

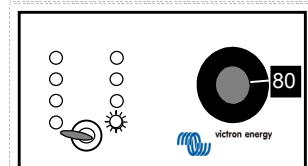

Battery type = 1. Gel

Warning: If the knob is not turned after an adjustment the charger will not store this adjustment. If the Float or Absorption voltage was adjusted and the charger is not switched off this voltage will remain on the outputs.

¹ The optimum absorption voltage of flat plate lead acid batteries depends on mechanical and chemical properties. Batteries with high antimony doping can general be charged with a lower absorption voltage than batteries with low antimony doping, like the Victory carbon fibre battery. (See the book "Electricity on board" at www.victronenergy.com)

After 4 hours the charger continues the normal sequence with the old value. This could be useful if a forced high voltage is wanted to get some life in an assumed 'dead' battery.

Return to factory defaults

- Switch the charger on.
- Keep the pushbutton \uparrow and/ or \downarrow pushed while switching **off**.
- The factory defaults are restored.
- Replace the frontplate.

SPECIFICATIONS

Model	12/50	12/30	24/25	24/16
Nominal input voltage range	120 - 240 Vac			
Absolute minimum working voltage	90 Vac			
Absolute maximum working voltage	265 Vac			
Frequency range	45 - 65 Hz			
Maximum input current	4A/230 Vac 10A/120 Vac			
Powerfactor (cos φ)	≈1			
Input fuse	15 AT 6.3 x 32 mm			
Absorption charge voltage default	14,4 Vdc		28,8 Vdc	
Float charge voltage default	13,8 Vdc		27,6 Vdc	
Adjustment range	12 - 16 Vdc		24 - 32 Vdc	
Bulk charge current shared between output +1 and output +2	50 Adc @ Vin=230Vac/Vout=12Vdc/Ta=25°C	30 Adc	25 Adc @ Vin=230Vac/Vout=24Vdc/Ta=25°C	16 Adc
Short circuit current	50 Adc	30Adc	25 Adc	16 Adc
Adjustment range	1 - 50 Adc	1 - 30 Adc	1 - 25 Adc	1 - 16 Adc
Maximum trickle charge current	4 Adc		4 Adc	
Current/voltage stability	±1%			
Output fuse	4x 20 A carfuse		2x 20 A carfuse	
Battery leakage current when charger is switched off	<2 mA			
Recommended battery capacity	200 - 400 Ah	100 - 200 Ah	100 - 200 Ah	45 - 100 Ah
Environment				
EMC	EEC 89/336			
Emission	EN55014 (1993)			
	EN61000-3-2			
	EN61000-3-3			
Immunity	EN55104 (1995)			
Safety	EN60335-2-29 (1991)			
Vibration	IEC68-2-6 : 10 - 150 Hz / 1.0 G			
Shock	IEC68-2-29: 1000 times XYZ +/- 10 G / 16 ms			
Operating temperature	0-40°C			
Transport & storage temperature	-20 - +60°C			
Relative humidity	max. 95% non condensing			
Noise	< 45 dB (A)			
Ventilation	Combined convection / forced-air			
Connections				
Mains connector	connection block provision for 4 mm ²			
Output +1/+2 battery connection	M6 bolts			
Trickle charge connection	connection block provision for 1.5 mm ²			
Earthing	M4 screw			
Temperature sensor	connection block provision for 1.5 mm ²			
Voltage sense	connection block provision for 1.5 mm ²			
Remote panel / RS485	RJ45 connector			
Mechanical				
Cabinet	Aluminium IP21, RAL5012 (blue) epoxy coated			
Size (h x w x d)	350 x 200 x 110 (mm)			
Weight	3.8 kg			
Weight including box	4.9 kg			

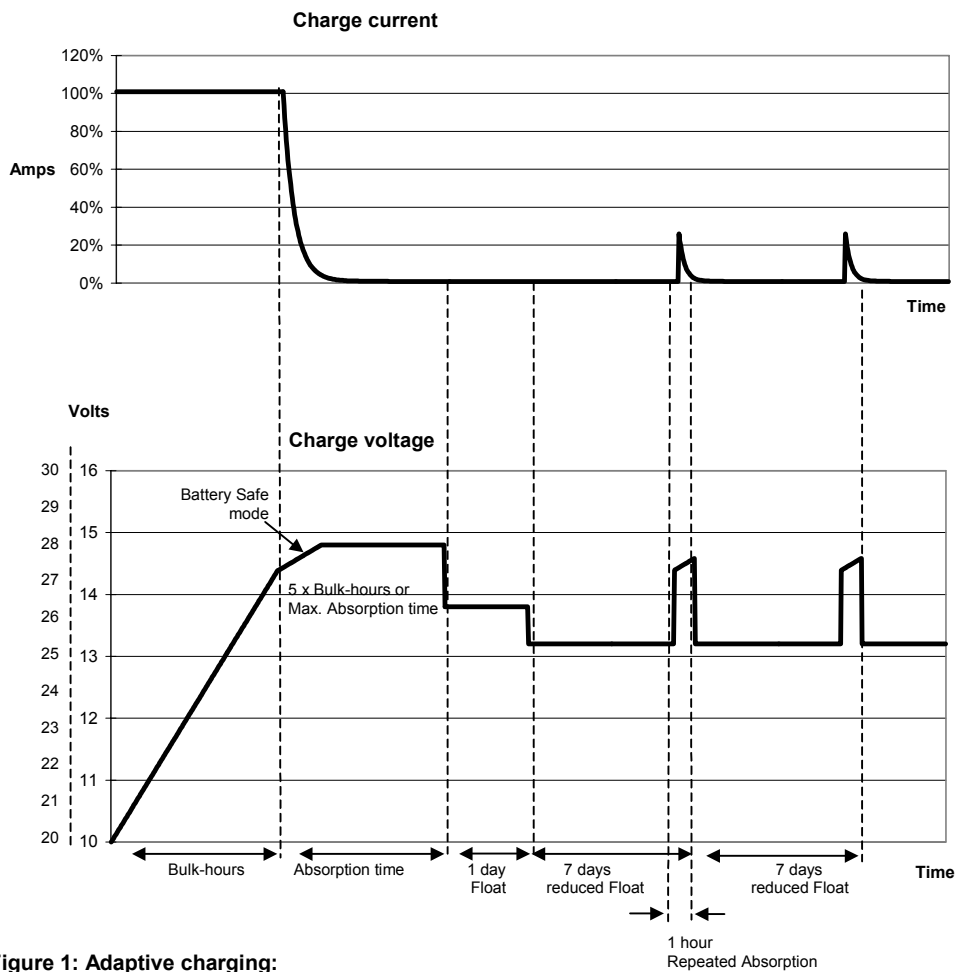

Figure 1: Adaptive charging:

Bulk-mode: Entered after a reset or if the battery voltage becomes 1.3V resp. 2.6V (for 12V and 24V charger) lower than Float voltage. Constant current is applied until the battery has reached 14.4V resp. 28.8V (for 12V and 24V charger, temperature compensated).

Battery Safe mode: The applied voltage to the battery is raised gradually until the set Absorption voltage is reached. The Battery Safe Mode is part of the calculated absorption time.

Absorption-mode: Absorption voltage is applied until $\{\text{actual-Bulk-Ah} \cdot 5 / \text{max.adjusted-Bulk-current}\}$ (in hours) is reached. Usually $\{\text{actual-Bulk-Ah} \cdot 5\} = \{\text{max.adjusted-Bulk-current} \cdot \text{Bulk-hours} \cdot 5\}$, but the actual-Bulk-current can be limited by ambient temperature, or remote-control. The maximum time in Absorption mode is the Maximum Absorption time set with control panel.

Float-mode: Float voltage is applied to keep the battery fully charged and to protect it against self discharge. After one day of Float charge a reduced Float charge is applied. This is 13V resp. 26V (for 12V and 24V charger, temperature compensated). This will limit water loss to a minimum when the battery is stored for the winter season.

After an adjustable time (default = 7 days) the charger will enter Repeated Absorption-mode for an adjustable time (default = 4 quarters).

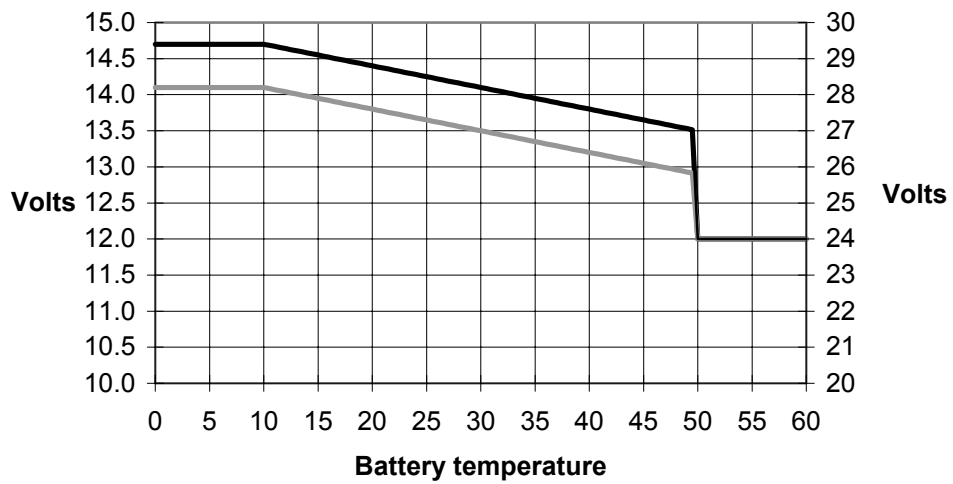

Figure 2: Temperature compensation

Default output voltages for Float and Absorption are at 20°C. In adjust mode temperature compensation does not apply.

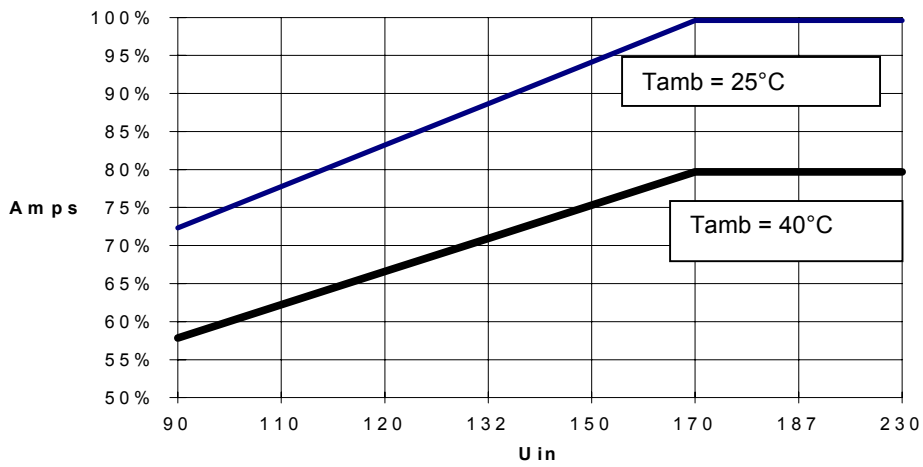

Figure 3: Maximum output current vs. input voltage:

Output voltage = 12.0V / 24.0V

Default factory settings:

Repeated Absorption interval	7 days				
Repeated Absorption time	4 quarters of an hour				
Maximum Absorption time	4 hrs				
Characteristic: Default = 3	1 = Fixed	Absorption time			4 hrs
		Repeated Absorption interval			1 day
		Repeated Absorption time			2 quarters
	2 = Adaptive				
	3 = Adaptive with Battery Safe Mode				
Battery type: Default = 1	Abs. Voltage		Float Voltage / Reduced Float		Max.Abs.time
0:User defined					
1: Sonnenschein Dryfit A200 Gel	14.4 V	28.8 V	13.8 V / 13.0V	27.6 V / 26.0V	4 hrs
2: Traction (Tubular plate)	15.0 V	30.0 V	13.8 V / 13.0V	27.6 V / 26.0V	6 hrs
3: Semitraction	14.4 V	28.8 V	14.0 V / 13.0V	28.0 V / 26.0V	5 hrs
4: Victory	14.8 V	29.6 V	14.0 V / 13.0V	28.0 V / 26.0V	5 hrs
	12V model	24V model	12V model	24V model	

Factory defaults can always be restored by your authorized Victron Energy dealer. Acting sequence is described in the installation part of the manual.

Serialnumber:

Dealer:

**Victron Energy B.V.
The Netherlands**

Phone : ** 31 36 535 97 00
Fax : ** 31 36 531 16 66
Customer support desk : ** 31 36 535 97 77
E-mail : sales@victronenergy.com
Internet site : <http://www.victronenergy.com>

Article Number : **ISM010001000**
Revision : **rev01**
Date : **26-03-02**